

Radiomuseum - Bocket.de 2018

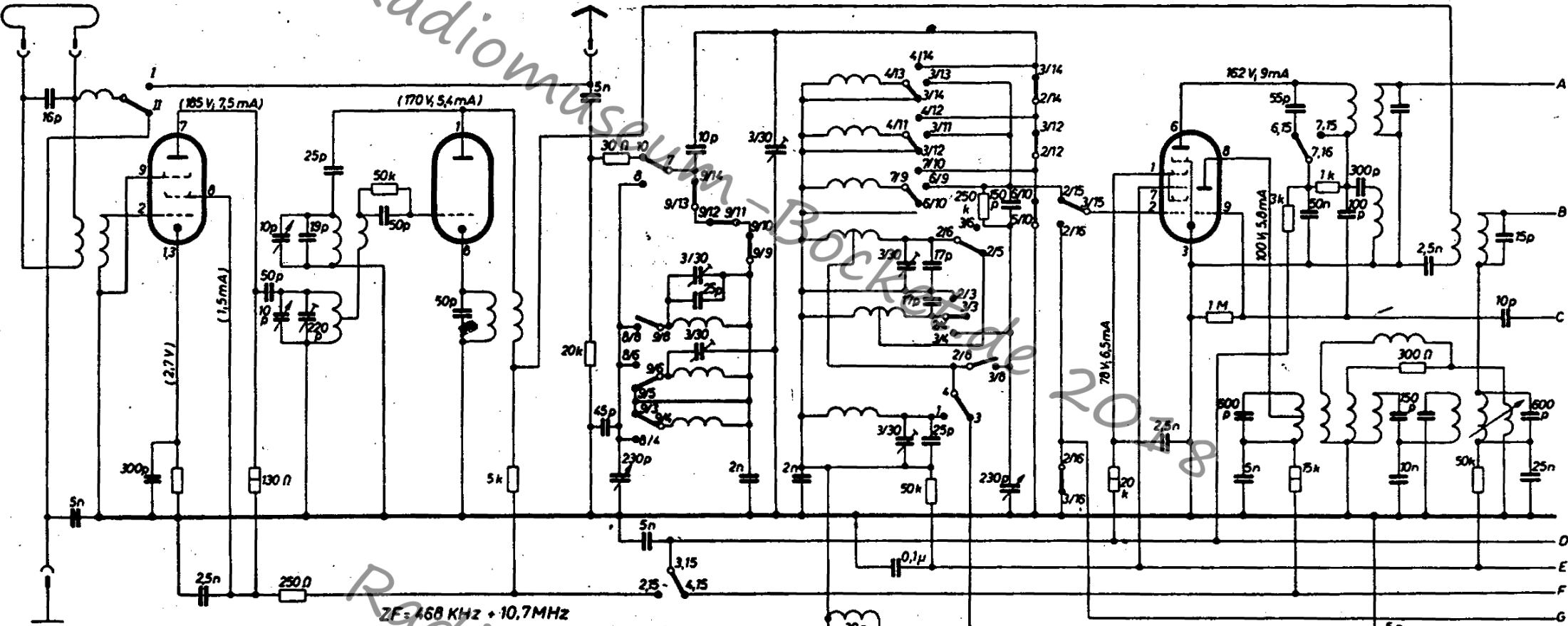

2F = 468 KHz + 10.7 MHz

(Q) L M N K R U FS E-A
 10 9 8 7 6 5 4 3 2 1

(V) Röhrenvoltmeter
 Meßwerte bei MW (UKW)

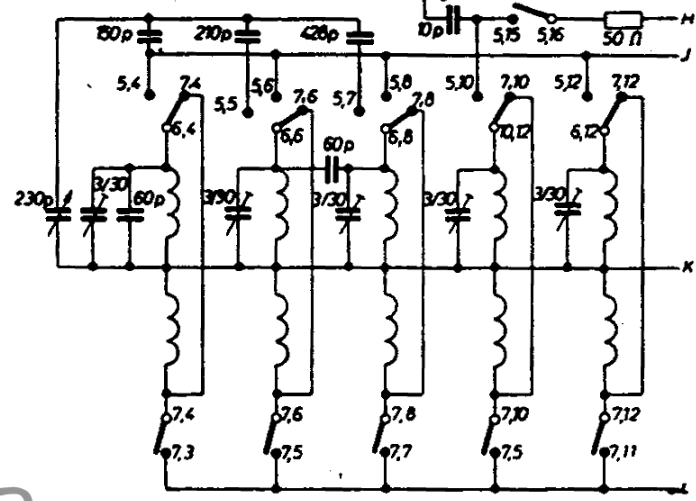
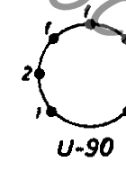
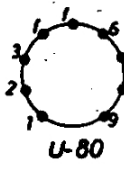
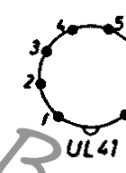
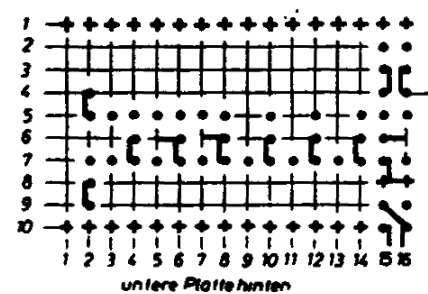
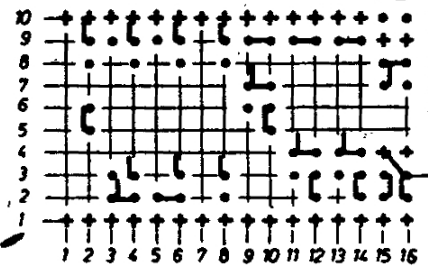

Grundig 5040 GW/3D

